

The First SUS Multiport Manifold on the Market

Nordson MEDICAL is proud to introduce the first all-in-one manifold for pharmaceutical and single-use biopharmaceutical fluid transfer applications. The revolutionary design of this patent-pending, compact fitting not only saves space, but also simplifies use and assembly. With five outlet ports available in one component, gone are the many leak points found in traditional stopcock and Y connector manifolds. Ideal for downstream processing, multiple bags can easily be filled from one large bag. Flow is consistent as it travels around the inner body of the part, maintaining a steady pressure. The large flow selector is effortless to turn, and the lock-in-place feature gives you assurance that you are utilizing the desired port.



Features & Benefits

- Can accommodate up to 5 fluid lines
- Flow restricted to one port at a time
- No pressure drop as fluid moves around & through the ports
- Intuitive push-to-turn flow selector
- Easier to use and fewer leak points than stopcock and Y connector manifolds
- Materials meet USP Class VI & ISO 10993 criteria
- Can be daisy chained for additional ports
- Arrows to provide a clear indication of how to turn the flow selector and which port is in use
- Etched data code for easy access to product resources and material information

Specifications

- **Materials:**
Body & Flow Selector - Gamma Stable Polycarbonate
Internal Spring - 316 Stainless Steel
Gasket - Platinum-Cured Silicone
- **Size:**
3/8" (9.5 mm) tubing IDs
- **Maximum Pressure:**
15 psi (1.0 bar)
- **Barb Size:**
600 Series

CYLINDRAFlow™

Manifolds

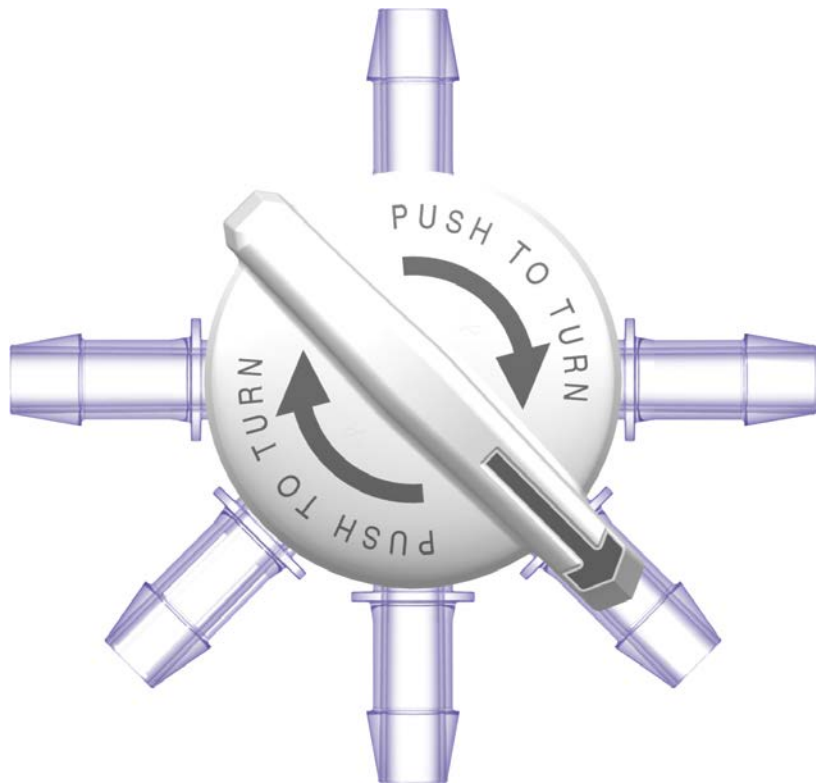

FMD5P670-001

Flow Manifold Director with 600 Series Barbs,
5 Output, 3/8" (9.5 mm) Tubing IDs, Polycarbonate

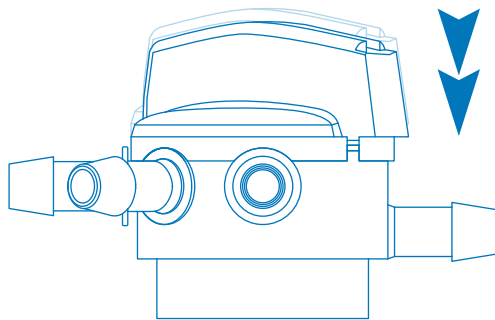

**Push and Turn
to Open Flow**

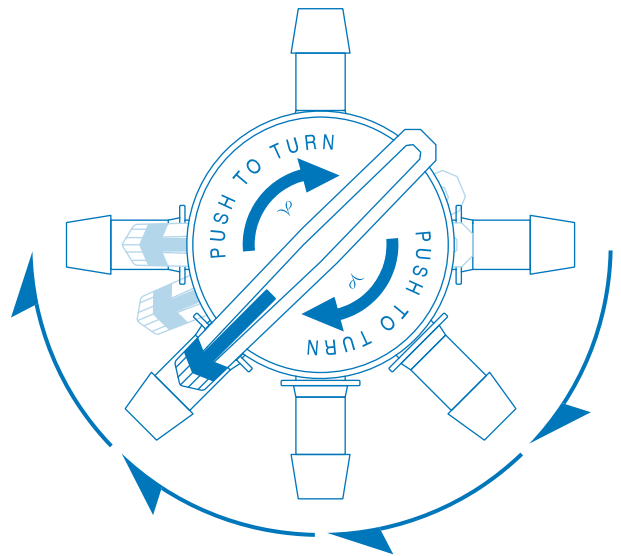

MAR-Manifolds-DS-01

Nordson MEDICAL
261 Cedar Hill Street
Marlborough, MA 01752, U.S.A.

+1.888.404.5837
+1.970.267.5200
nordsonmedical.com

**Nordson**
MEDICAL

IN-STOCK

Components & Tools



Experts in Medical Device Design, Manufacturing & Component Technologies

Browse our online store, with more than 7,000 stock components and technologies, most ready to ship within 24 hours.



Components & Technologies



Catheters & Cannulae

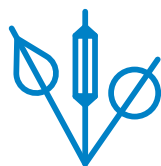

Medical Balloons

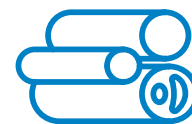

Medical Tubing

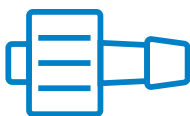

Fluid Management Components

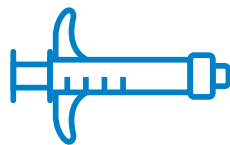

Biomaterial Delivery Devices



Nitinol Components