

REVISIONS						
SHEET	ZONE	REV.	ECO	DESCRIPTION	DATE	APPROVED
1	ALL	A	ADDED O-RING LUBRICATION NOTE	6/19/2014	HRC
1	ALL	A	50093	INITIAL RELEASE	9/10/2014	HRC
1	ALL	B	50257	O-RING AND DWG FORMAT UPDATE	06/12/2018	HRC

PLUG,
(POLYPROPYLENE)

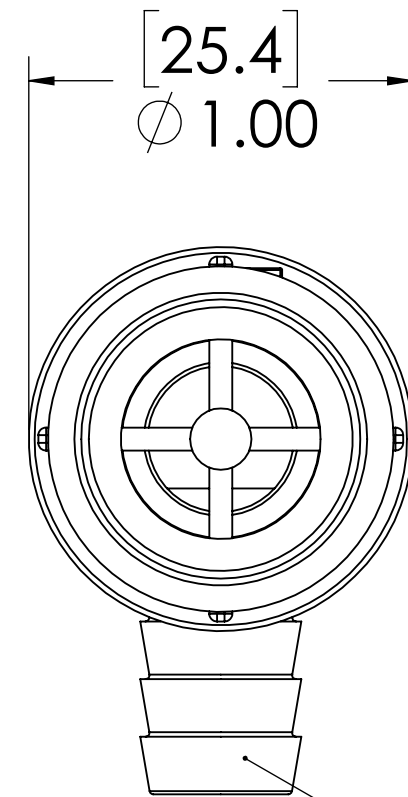
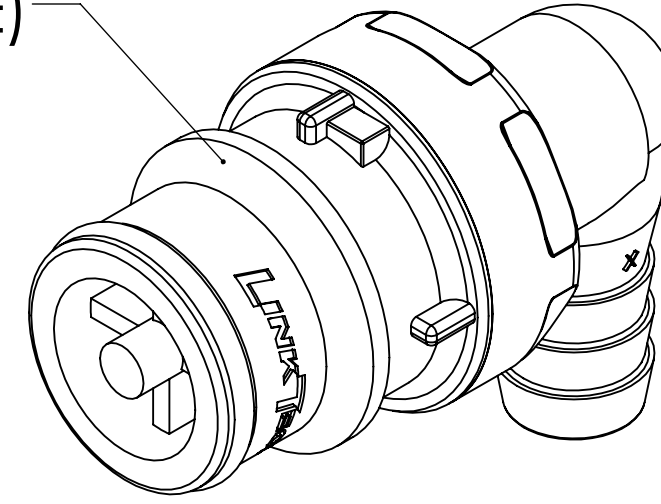

3/8" TUBE ID

O-RING,
(EPDM)

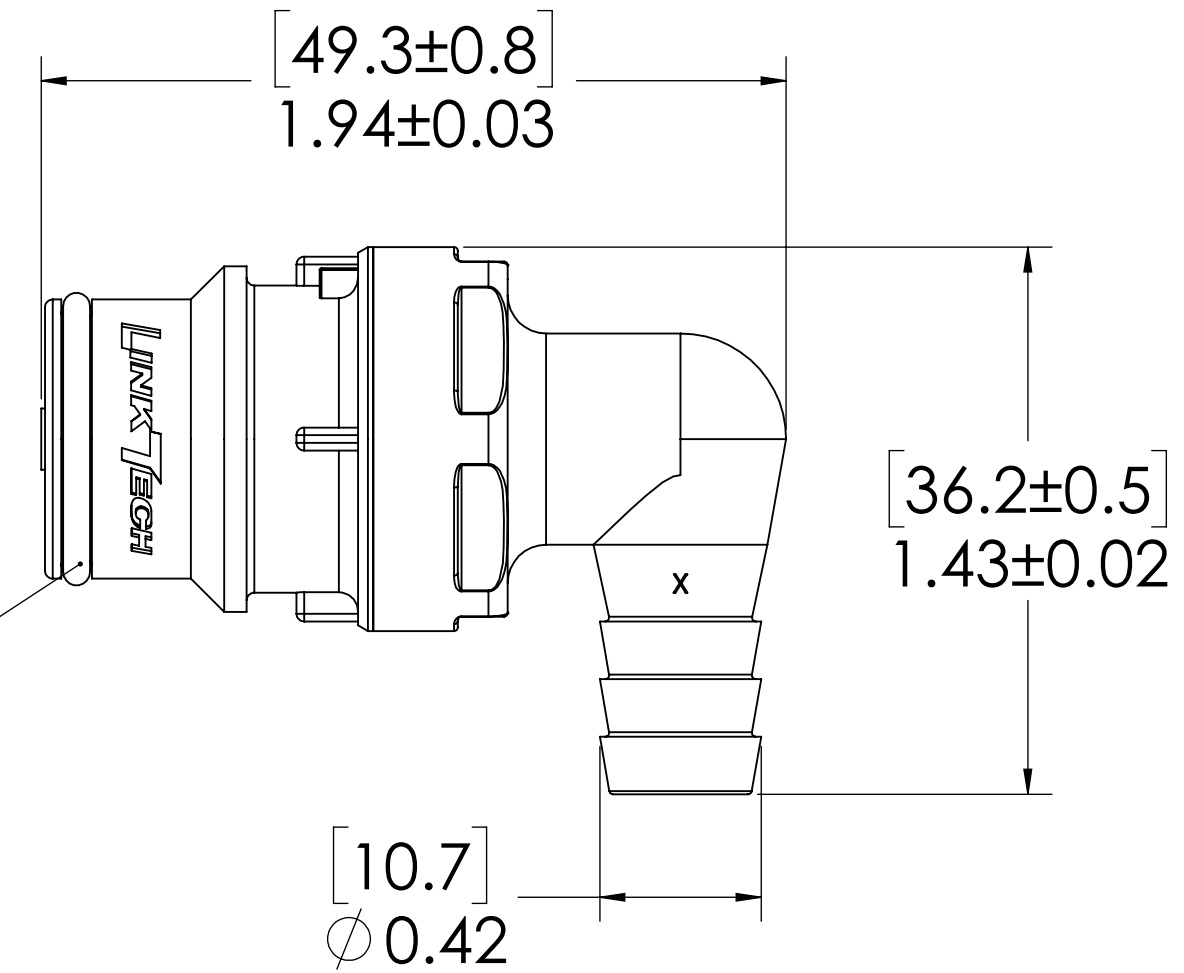

NOTES:

1. MATERIAL: POLYPROPYLENE
2. COLOR: GREY
3. O-RING MATERIAL: EPDM
4. O-RINGS LUBRICATED WITH FOOD GRADE SILICONE OIL, 350 CST.

FOR REFERENCE ONLY

<small>UNLESS OTHERWISE SPECIFIED: DIMENSIONS ARE IN INCHES TOLERANCES: FRACTIONAL ± 1/32 ANGULAR: MACH ± 0.5 BEND ± 2 ONE PLACE DECIMAL ± 0.1 TWO PLACE DECIMAL ± 0.01 THREE PLACE DECIMAL ± 0.005 TWO PLACE DUAL (mm) [±0.12]</small>	DRAWN	HRC	8/20/13	
	CHECKED	CKE	6/12/18	
	ENG APPR.	HRC	6/12/18	
	MFG APPR.	BDB	6/12/18	
PRODUCTION	LAS	6/12/18		PART NO: 60PP-PE4-06 DESCRIPTION: LinkTech 60PP Series Elbow Male, Non-valved 3/8" HB, Polypropylene
<small>PROPRIETARY AND CONFIDENTIAL THE INFORMATION CONTAINED IN THIS DRAWING IS THE SOLE PROPERTY OF LINKTECH LLC. ANY REPRODUCTION OR DISCLOSURE IN PART OR AS A WHOLE WITHOUT THE WRITTEN PERMISSION OF LINKTECH LLC IS STRICTLY PROHIBITED.</small>	COMMENTS:			SIZE DWG. NO. REV C 60PP600048 B
SCALE: NTS		WEIGHT:	SHEET 1 OF 1	