

NOTE: FOR MORE DETAILS SEE YOUR V.P. CUSTOMER SERVICE REP.

REVISIONS			
REV.	DESCRIPTION	DATE	APPROVED
A	INITIAL RELEASE	04-03-98	
B	CO 039 Drafting Update	05-08-06	Rick C.

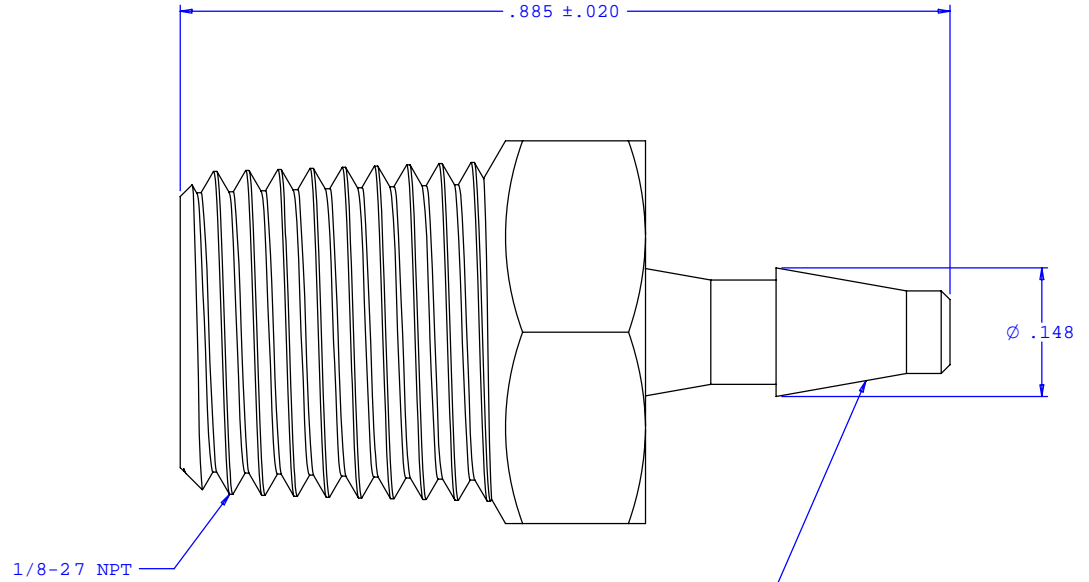

INSTRUMENT QUALITY PART. NO PARTING LINE PERMITTED ON THIS CONICAL SURFACE

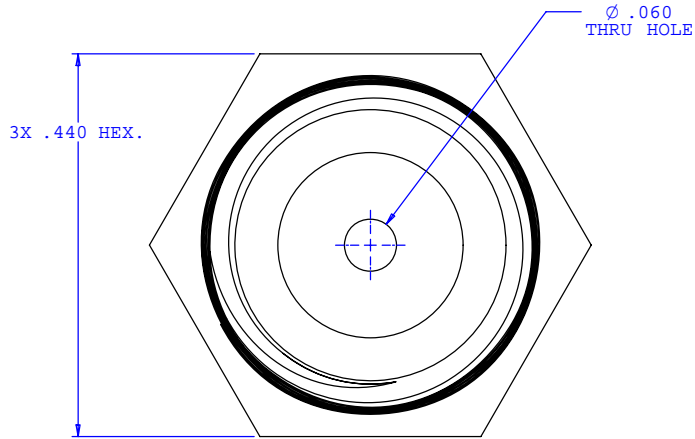
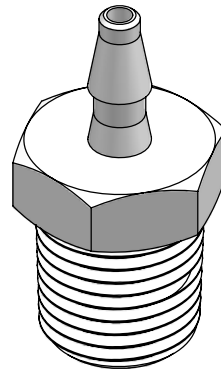

UNLESS OTHERWISE SPECIFIED DIMENSIONS ARE IN INCHES TOLERANCES ARE:		VALUE PLASTICS, INC.	
FRACTIONS ±	DECIMALS .XX ±.01 .XXX ±.005 .XXXX ±.001	ANGULAR ±1°	PART NUMBER: 1820
DO NOT SCALE DRAWING		DESCRIPTION: 1/8-27 NPT Thread with 7/16" Hex to Classic Series Barb, 3/32" (2.25 mm) ID Tubing	
DRAWN BY: Frank Lombardi	DATE: 02-11-06	SIZE: B	SCALE: NTS
Engineer/Manager: Rick Cairns		DRAWING NUMBER: 1008271	REV. B
© 2006 VALUE PLASTICS, INC.		SHEET: 1 OF 1	

FOR REFERENCE ONLY