

NOTE: FOR MORE DETAILS SEE YOUR V.P. CUSTOMER SERVICE REP.

REVISIONS			
REV.	DESCRIPTION	DATE	APPROVED
A	INITIAL RELEASE	03-31-98	
B	CO 018 Drafting Update	07-09-05	RICKC

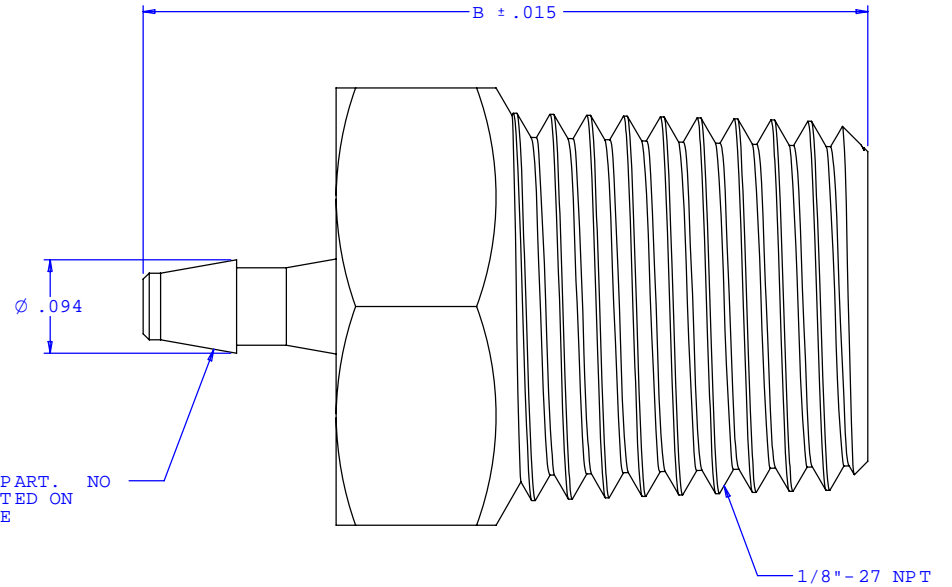

INSTRUMENT QUALITY PART. NO PARTING LINE PERMITTED ON THIS CONICAL SURFACE

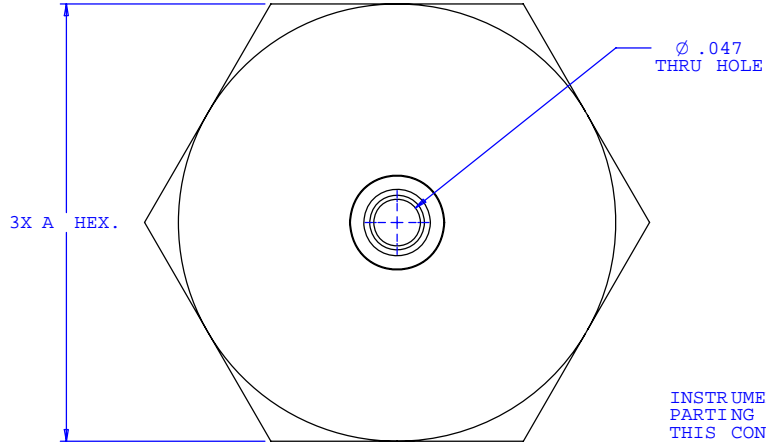
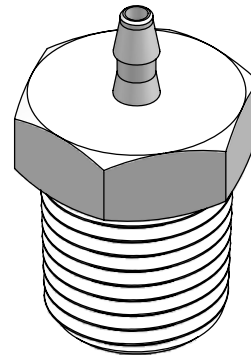

Dimension	Material Specific Tolerances							
	Acetal	Nylon	PP	ABS	PC	PVC	Polysulfone	J1A
A	0.440	0.435	0.440	0.440	0.440	0.440	0.440	0.435
B	0.729	0.729	0.729	0.729	0.729	0.729	0.729	0.714
C								
D								
E								
F								

UNLESS OTHERWISE SPECIFIED DIMENSIONS ARE IN INCHES TOLERANCES ARE:		VALUE PLASTICS, INC.	
FRACTIONS ±	DECIMALS .XX ±.01 .XXX ±.005 .XXXX ±.001	ANGULAR ±1°	PART NUMBER: 18210
DO NOT SCALE DRAWING		DESCRIPTION: 1/8-27 NPT Thread with 7/16" Hex to 200 Series Barb, 1/16" (1.5 mm) ID Tubing	
DRAWN BY: Frank Lombardi	DATE: 06-10-05	SIZE: B	SCALE: NTS
ENGINEER/ MANAGER: Rick Cairns		DRAWING NUMBER: 1006890	REV. B
© 2005 VALUE PLASTICS, INC.			SHEET: 1 OF 1

FOR REFERENCE ONLY