

NOTE: FOR MORE DETAILS SEE YOUR V.P. CUSTOMER SERVICE REP.

REVISIONS			
REV.	DESCRIPTION	DATE	APPROVED
A	INITIAL RELEASE	12-03-99	
B	CO 039 Drafting Update	04-12-06	Rick C.

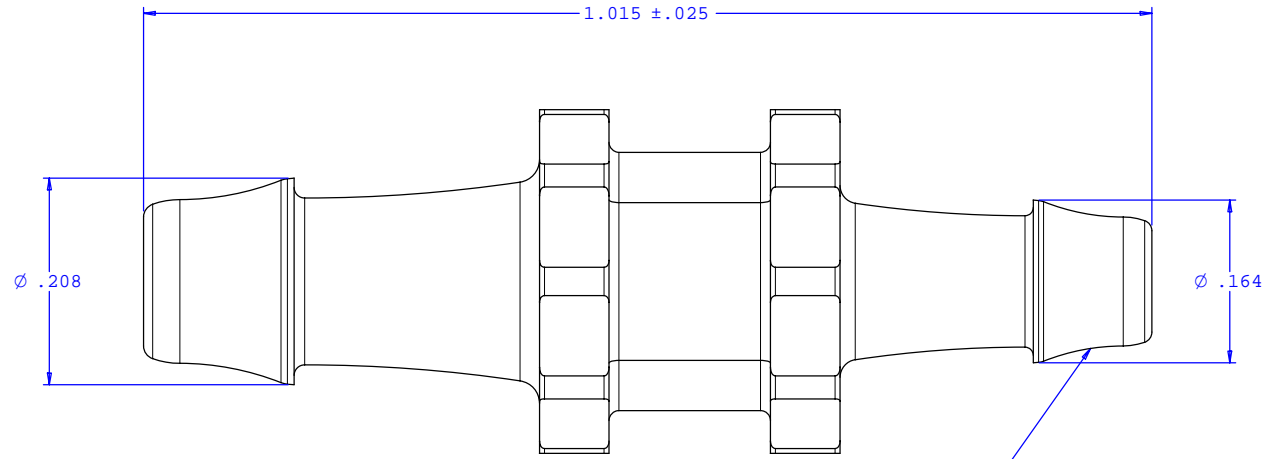

2X INSTRUMENT QUALITY PART. NO PARTING LINE PERMITTED ON THIS CONICAL SURFACE

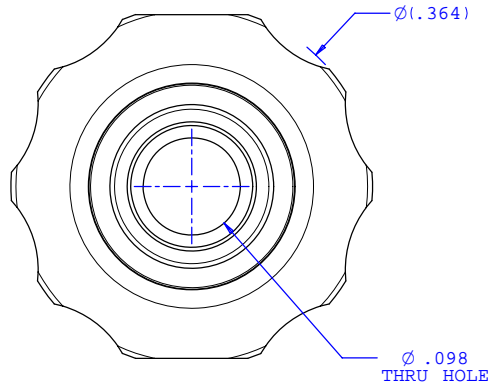
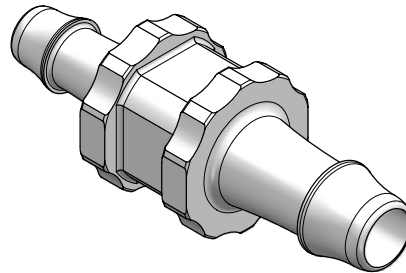

UNLESS OTHERWISE SPECIFIED DIMENSIONS ARE IN INCHES TOLERANCES ARE:		<b>VALUE PLASTICS, INC.</b>	
FRACTIONS ±	DECIMALS .XX ±.01 .XXX ±.005 .XXXX ±.001	ANGULAR ±1°	PART NUMBER: <b>N025/013</b>
DO NOT SCALE DRAWING		DESCRIPTION: Straight Through Reduction Connector with 500 Series Barbs, 5/32" (4 mm) and 1/8" (3 mm) ID Tubing	
DRAWN BY: <b>Frank Lombardi</b>	DATE: <b>01-28-06</b>	SIZE: <b>B</b>	SCALE: <b>NTS</b>
Engineer/Manager: <b>Rick Cairns</b>		DRAWING NUMBER: <b>1008178</b>	REV. <b>B</b>
© 2006 VALUE PLASTICS, INC.			SHEET: 1 OF 1

**FOR REFERENCE ONLY**