

NOTE: FOR MORE DETAILS SEE YOUR V.P. CUSTOMER SERVICE REP.

REVISIONS			
REV.	DESCRIPTION	DATE	APPROVED
A	INITIAL RELEASE	03-14-03	
B	CO 046 Drafting Update	08-22-06	Rick C.

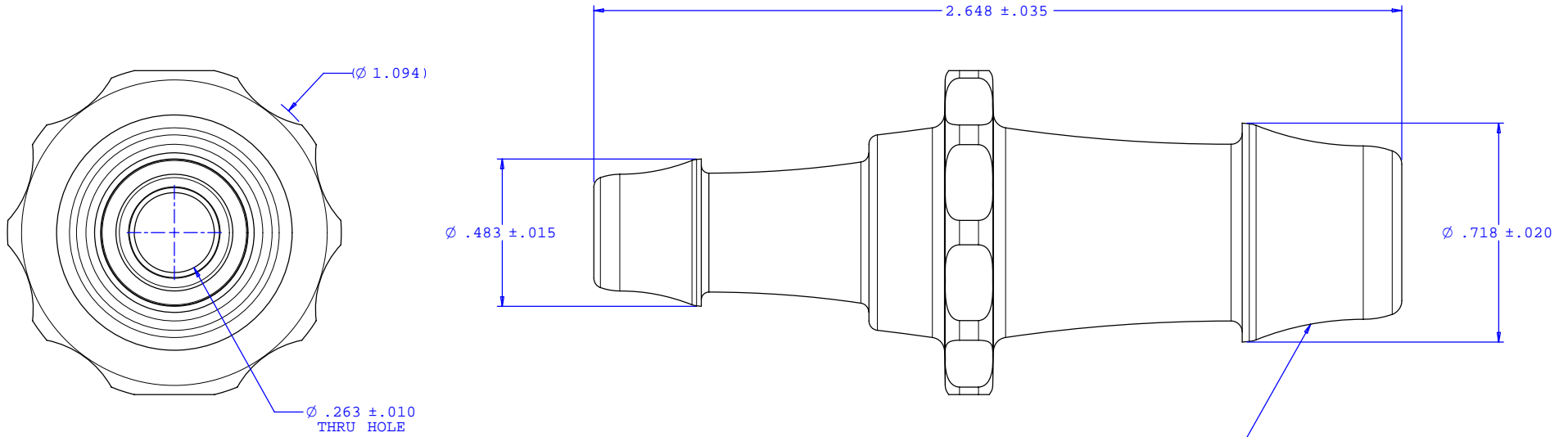

2X INSTRUMENT QUALITY PART. NO PARTING LINE PERMITTED ON THIS CONICAL SURFACE

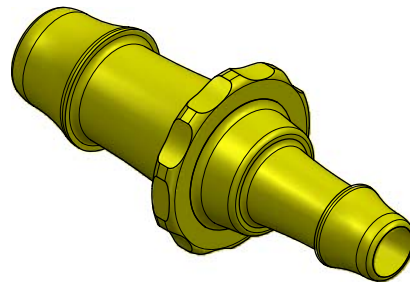

UNLESS OTHERWISE SPECIFIED DIMENSIONS ARE IN INCHES TOLERANCES ARE:		VALUE PLASTICS, INC.	
FRACTIONS ±	DECIMALS .XX ±.01 .XXX ±.005 .XXXX ±.001	ANGULAR ±1°	PART NUMBER: N090/070
DO NOT SCALE DRAWING		DESCRIPTION: Straight Through Reduction Connector With 500 Series Barbs, 5/8" (16 mm) and 3/8" (9.5 mm) ID Tubing	
DRAWN BY: Frank Lombardi	DATE: 06-10-06	SIZE: B SCALE: NTS	DRAWING NUMBER: 1008981 REV. B
Engineer/Manager: Rick Cairns		© 2006 VALUE PLASTICS, INC. SHEET: 1 OF 1	

FOR REFERENCE ONLY