

NOTE: FOR MORE DETAILS SEE YOUR V.P. CUSTOMER SERVICE REP.

REVISIONS			
REV.	DESCRIPTION	DATE	APPROVED
A	ECO#0002	11-26-02	
B	CO 024 Drafting Update	09-14-05	Rick C.

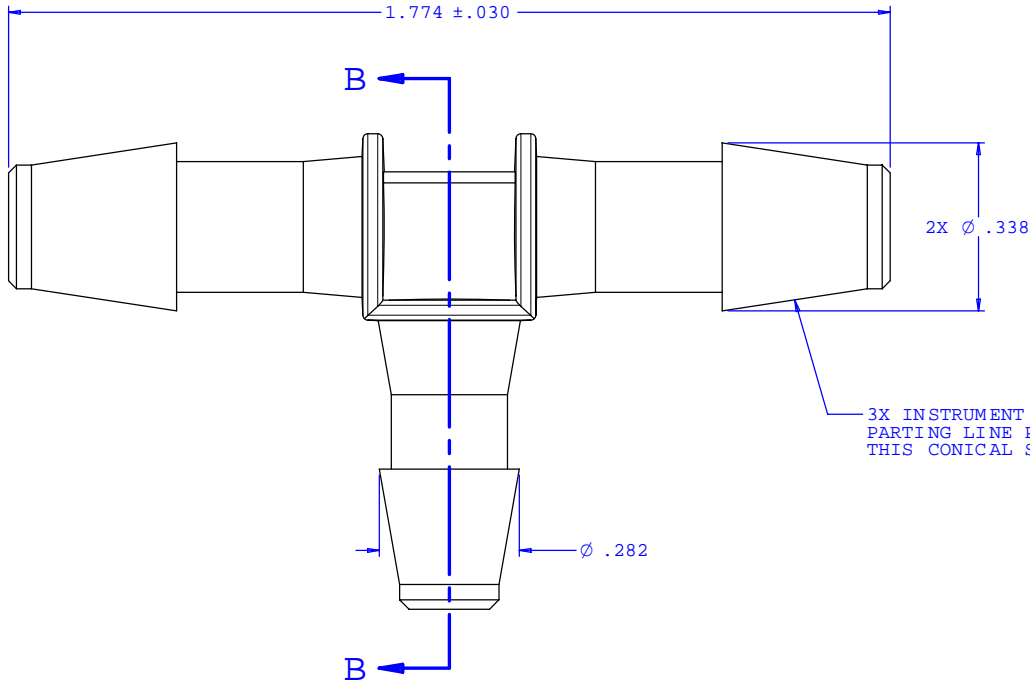

3X INSTRUMENT QUALITY PART. NO PARTING LINE PERMITTED ON THIS CONICAL SURFACE

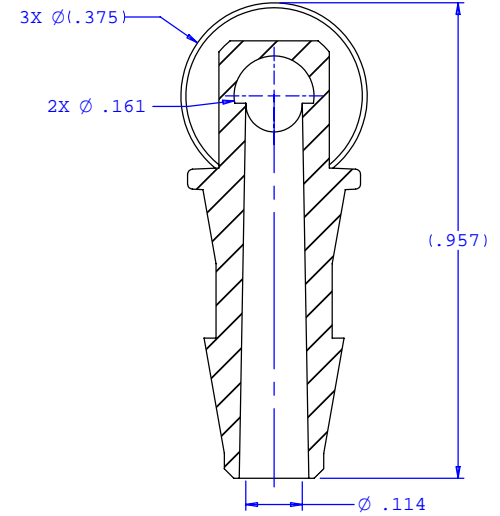

SECTION B-B

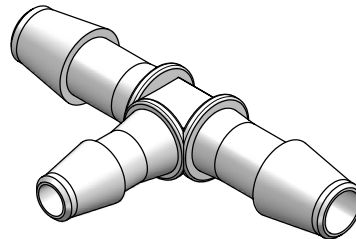

UNLESS OTHERWISE SPECIFIED DIMENSIONS ARE IN INCHES TOLERANCES ARE:		VALUE PLASTICS, INC.	
FRACTIONS ±	DECIMALS .XX ±.01 .XXX ±.005 .XXXX ±.001	ANGULAR ±1°	PART NUMBER: T360-250
DO NOT SCALE DRAWING		DESCRIPTION: Tee Reduction Connector with 200 and 300 Series Barbs, 1/4" (6.25 mm) and 3/16" (4.75 mm) ID Tubing	
DRAWN BY: Frank Lombardi	DATE: 07-28-05	SIZE: B	SCALE: NTS
Engineer/Manager: Rick Cairns		DRAWING NUMBER: 1007225	REV. B
© 2005 VALUE PLASTICS, INC.			SHEET: 1 OF 1

FOR REFERENCE ONLY