

NOTE: FOR MORE DETAILS SEE YOUR V.P. CUSTOMER SERVICE REP.

REVISIONS			
REV.	DESCRIPTION	DATE	APPROVED
A	INITIAL RELEASE	04-12-02	
B	CO 024 Drafting Update	10-04-05	Rick C.

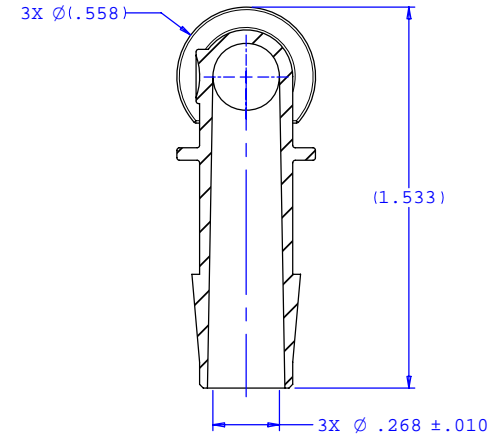

SECTION B-B

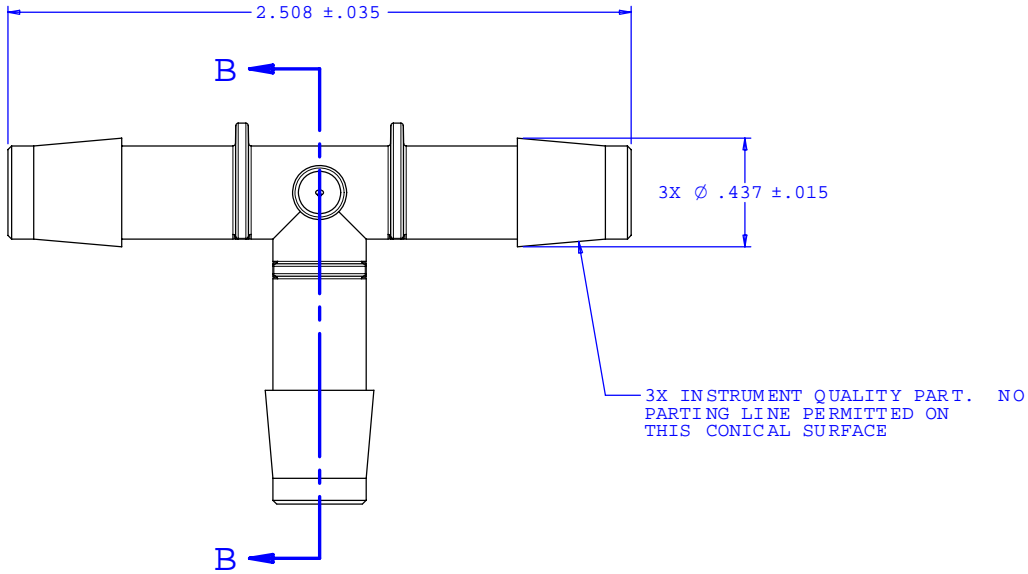
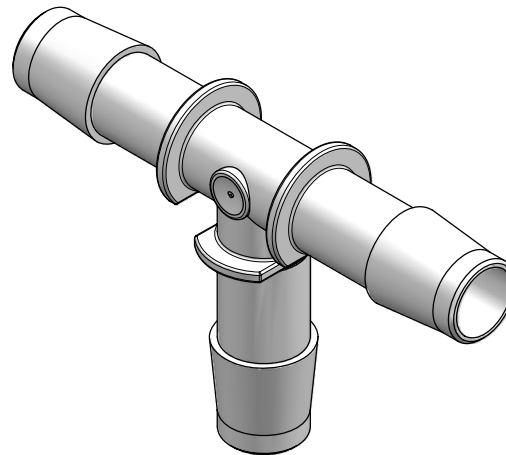

UNLESS OTHERWISE SPECIFIED DIMENSIONS ARE IN INCHES TOLERANCES ARE:		VALUE PLASTICS, INC.	
FRACTIONS ±	DECIMALS .XX ±.01 .XXX ±.005 .XXXX ±.001	ANGULAR ±1°	PART NUMBER: T970
DO NOT SCALE DRAWING		DESCRIPTION: Tee Connector with 900 Series Barbs, 3/8" (9.5 mm) ID Tubing	
DRAWN BY: Frank Lombardi	DATE: 07-29-05	SIZE: B	SCALE: NTS
ENGINEER/ MANAGER: Rick Cairns		DRAWING NUMBER: 1007243	REV. B
© 2005 VALUE PLASTICS, INC.			SHEET: 1 OF 1

FOR REFERENCE ONLY