

NOTE: FOR MORE DETAILS SEE YOUR V.P. CUSTOMER SERVICE REP.

REVISIONS			
REV.	DESCRIPTION	DATE	APPROVED
A	INITIAL RELEASE	07-24-97	
B	CO 018 Drafting Update	08-18-05	RICKC

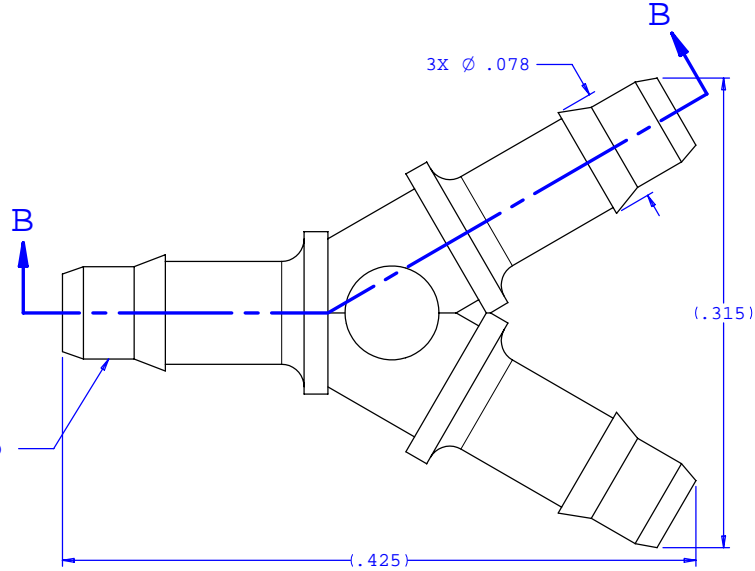

3X INSTRUMENT QUALITY PART. NO PARTING LINE PERMITTED ON THIS CONICAL SURFACE

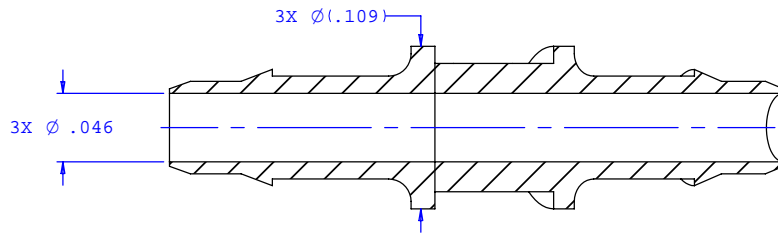
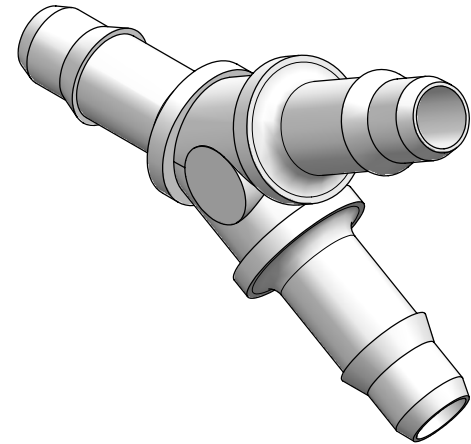

SECTION B-B

UNLESS OTHERWISE SPECIFIED DIMENSIONS ARE IN INCHES TOLERANCES ARE:		VALUE PLASTICS, INC.	
FRACTIONS ±	DECIMALS ±	ANGULAR ±1°	PART NUMBER: Y410
.XX ±.01	.XXX ±.005		DESCRIPTION: y Connector with 400 Series Barbs, 1/16" (1.5 mm) ID Tubing
.XXXX ±.001			
DO NOT SCALE DRAWING			
DRAWN BY: Frank Lombardi	DATE: 06-15-05	SIZE: B	SCALE: NTS
ENGINEER/MANAGER: Rick Cairns		DRAWING NUMBER: 1006918	REV. B
© 2005 VALUE PLASTICS, INC.			SHEET: 1 OF 1

FOR REFERENCE ONLY